

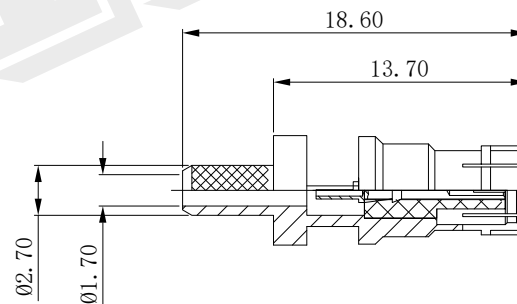

版本 Rev	说明 Description	日期 Date	批准 Appr
A	初次发行	2023.02.05	Gavin

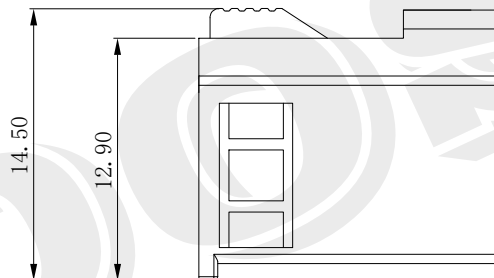
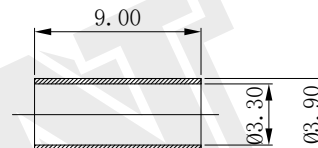
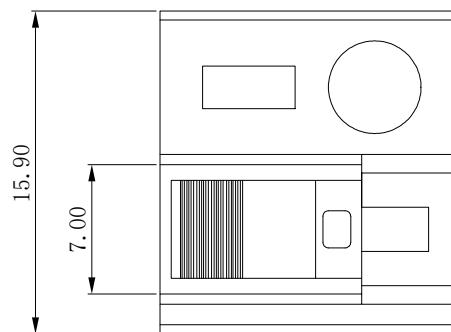

Technical parameter:
 Impedance: 50 Ω
 Frequency Range: DC~4GHz
 VSWR≤1.5
 Workin Voltage: 335V max (有效值)
 Withstand Voltage: 700V rms (海平面最小值)
 Contact resistance:
 Center Contact: ≤6mΩ
 Outer Contact: ≤1mΩ
 Insulation resistance: ≥1000M Ω
 Vibration: 100m/S3 (80~2000Hz)
 Impact: 500m/S2
 Durability (mating): ≥500次(cycles)
 Inner Conductor: ≥0.28N
 Outer Conductor: ≥8N
 Temp. range: -55~+155°C (PE Cable -40+85°C)

6	Copper tube	Brass	Nickel-plated	1
5	Center Pin	Brass	Nickel-plated	1
4	Insulator	PTFE	White	1
3	Body	Brass	Nickel-plated	1
2	Buckle	PA66+15%GF		1
1	Shell	PA66+15%GF		1
NO	名称 (NAME)	规格 (SPECIFICATION)	表面处理 (FINISH)	用量(QTY)











东莞市德索精密工业有限公司

未注公差
 TOLERANCE UNSPECIFIED
 0.5 - 8mm ± 0.15mm
 8 - 30mm ± 0.20mm
 30 - 120mm ± 0.30mm
 X° ± 2°
 X.X° ± 1°

图号 DWG NO	品名 PART NAME	FAKRA FEMALE DUAL CAVITY FOR RG174 CABLE			
批准 Appr	料号 PART NO.	DOSIN-877-2029			
审核 Check	日期 Date	比例 Scale	单位 Unit	版本 Rev	页码 Page
绘图 Draw	GAVIN	2023.02.05	1:1	MM	A
					1/2

版本 Rev	说明 Description	日期 Date	批准 Appr
A	初次发行	2023.02.05	Gavin

Coding	Graphics	Colour	Product NO.
A		Black RAL9005	DOSIN-877-2029-A
B		White RAL9001	DOSIN-877-2029-B
C		Blue RAL5005	DOSIN-877-2029-C
D		Bordeaux RAL4004	DOSIN-877-2029-D
E		Green RAL6002	DOSIN-877-2029-E
F		Brown RAL8011	DOSIN-877-2029-F
G		Gray RAL7031	DOSIN-877-2029-G

Coding	Graphics	Colour	Product NO.
H		Violet RAL4003	DOSIN-877-2029-H
I		Beige RAL1001	DOSIN-877-2029-I
K		Curry RAL1027	DOSIN-877-2029-K
L		Carmine Red RAL3002	DOSIN-877-2029-L
M		Pastel Orange RAL2003	DOSIN-877-2029-M
N		Pastel Green RAL6019	DOSIN-877-2029-N
Z		Water Blue RAL5021	DOSIN-877-2029-Z



东莞市德索精密工业有限公司

 未注公差 TOLERANCE UNSPECIFIED 0.5 - 8mm ± 0.15mm 8 - 30mm ± 0.20mm 30 - 120mm ± 0.30mm X° ± 2° X.X° ± 1°	图号 DWG NO		品名 PART NAME	FAKRA FEMALE DUAL CAVITY FOR RG174 CABLE			
	批准 Appr		料号 PART NO.	DOSIN-877-2029			
	审核 Check		日期 Date	比例 Scale	单位 Unit	版本 Rev	页码 Page
	绘图 Draw	GAVIN	2023.02.05	1:1	MM	A	2/2