

HSF

NOTES:

Current Rating: 1.0AMP
 Contact Resistance: 30mΩ Max
 Withstand Voltage: 500V AC
 Insulation Resistance: 1000MΩ Min
 Operation Temperature: -55℃ to +130℃

Contact Material: Phosphor Bronze
 Contact plating: Au Or Sn over Ni
 Insulator Material: LCP+30%G.F UL94V-0

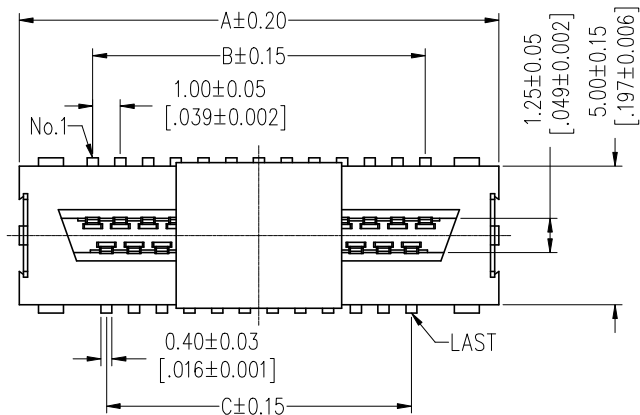

Recommended P.C.B Layout(Top Side)
 (PCB BOARD TOLERANCE±0.05)

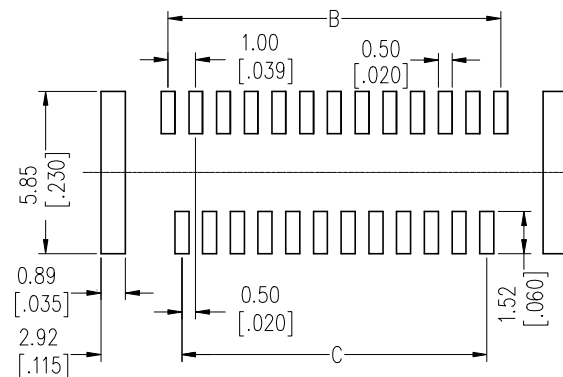

Ordering Information

3640-P XXX - XXX XX R 01

No. of Pins	High "H1"	Contact Plating	Packing
09~69P	0.86=008	S1=3u"Gold/Tin	T=Tube
	1.23=012	S3=10u"Gold/Tin	P=Tube+CAP
	1.73=017	S4=15u"Gold/Tin	R=Tape&Reel+CAP
	2.23=022	S5=30u"Gold/Tin	
	2.72=027		
	3.72=037		
	4.23=042		

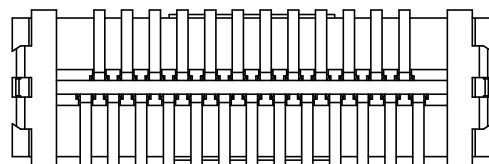
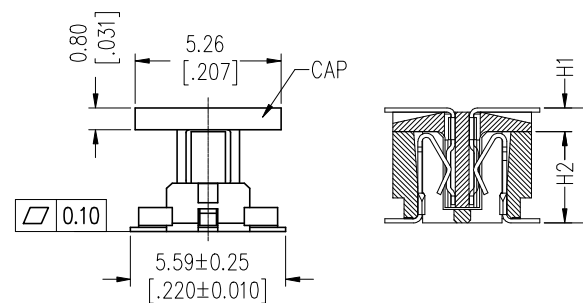
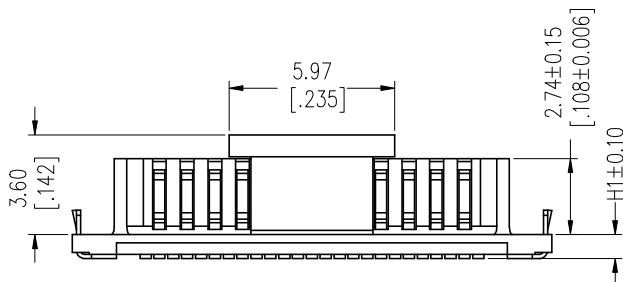

H	H1	H2	Dimension			
			A	B	C	
Total High	Plug	Socket	09	9.30	4.00	3.00
4.15	0.86	3.28	11	10.30	5.00	4.00
4.50	1.23		15	12.30	7.00	6.00
5.00	1.73		21	15.30	10.00	9.00
5.50	2.23		25	17.30	12.00	11.00
6.00	2.72		31	20.30	15.00	14.00
7.00	3.72		41	25.30	20.00	19.00
7.52	4.23		51	30.30	25.00	24.00
			69	39.30	34.00	33.00

OPERATION	DRAW	DATE	SCALE	FIT	PART NO.
x.x ±0.40	DuYing	2020/08/25	UNIT	mm	RH-3640-PXXX-047XXR01
x.xx ±0.25	CHECK	DATE	SIZE	A4	TITLE: 1.00mm B TO B SMT Type Plug H=2.10
x.xxx ±0.15	APPROVE	DATE	SHEET	1/1	Customer NO.
Angle ± 3'			PROJ.	⌀	
DIM TOL					



<https://www.renhotec.com>

info@renhotec.com

REV	DATE	MODIFICATION DESCRIPTION	CHANGE
A1	2020/08/25	Modify	DuYing
A0	2012/11/22	NEW	JYHuang